

LME49722 Low Noise, High Performance, High Fidelity Dual Audio Operational Amplifier

Check for Samples: [LME49722](#)

FEATURES

- Easily Drives 600Ω Loads
- Optimized for Superior Audio Signal Fidelity
- Output Short Circuit Protection
- PSRR and CMRR Exceed 120dB (typ)

APPLICATIONS

- Ultra High Quality Audio Amplification
- High Fidelity Preamplifiers, Phono Preamps, and Multimedia
- High Performance Professional Audio
- High Fidelity Equalization and Crossover Networks with Active Filters
- High Performance Line Drivers and Receivers
- Low Noise Industrial Applications Including Test, Measurement, and Ultrasound

DESCRIPTION

The LME49722 is part of the ultra-low distortion, low noise, high slew rate operational amplifier series optimized and fully specified for high performance, high fidelity applications. Combining advanced leading-edge process technology with state-of-the-art circuit design, the LME49722 audio operational amplifiers deliver superior audio signal amplification for outstanding audio performance. The LME49722 combines extremely low voltage noise density (1.9nV/√Hz) rate with vanishingly low THD+N (0.00002%) to easily satisfy the most demanding audio applications. To ensure that the most challenging loads are driven without compromise, the LME49722 has a high slew rate of ±22V/μs and an output current capability of ±28mA. Further, dynamic range is maximized by an output stage that drives 2kΩ loads to within 1V of either power supply voltage.

The LME49722 has a wide supply range of ±2.5V to ±18V. Over this supply range the LME49722 maintains excellent common-mode and power supply rejection, and low input bias current. This Audio Operational Amplifier achieves outstanding AC performance while driving complex loads with values as high as 100pF with gain value greater than 2. Directly interchangeable with LME49720, LM4562 and LME49860 for similar operating voltages.

Table 1. KEY SPECIFICATIONS

	VALUE	UNIT
Wide Operating Voltage Range	±2.5V to ±18	V
Equivalent Noise (Frequency = 1kHz)	1.9	nV/√Hz (typ)
Equivalent Noise (Frequency = 10Hz)	2.8	nV/√Hz (typ)
PSRR	120	dB (typ)
Slew Rate	±22	V/μs (typ)
THD+N ($A_V = 1$, $V_{OUT} = 3V_{RMS}$, $f_{IN} = 1kHz$)	$R_L = 2k\Omega$	0.00002 % (typ)
	$R_L = 600\Omega$	0.00002 % (typ)
Open Loop Gain ($R_L = 600\Omega$)	135	dB (typ)
Input Bias Current	50	nA (typ)
Voltage Offset	±0.02	mV (typ)



Please be aware that an important notice concerning availability, standard warranty, and use in critical applications of Texas Instruments semiconductor products and disclaimers thereto appears at the end of this data sheet.

All trademarks are the property of their respective owners.

Typical Application

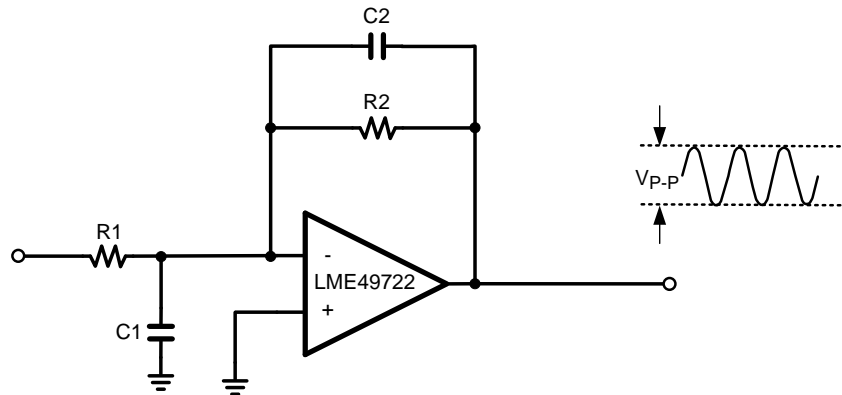

$f_{MAX} = > 300 \text{ kHz for } V_{p-p} = 20V, R_2 C_2 \approx R_1 C_1$

Figure 1. Wide Bandwidth Low Noise Low Drift Amplifier

Connection Diagram

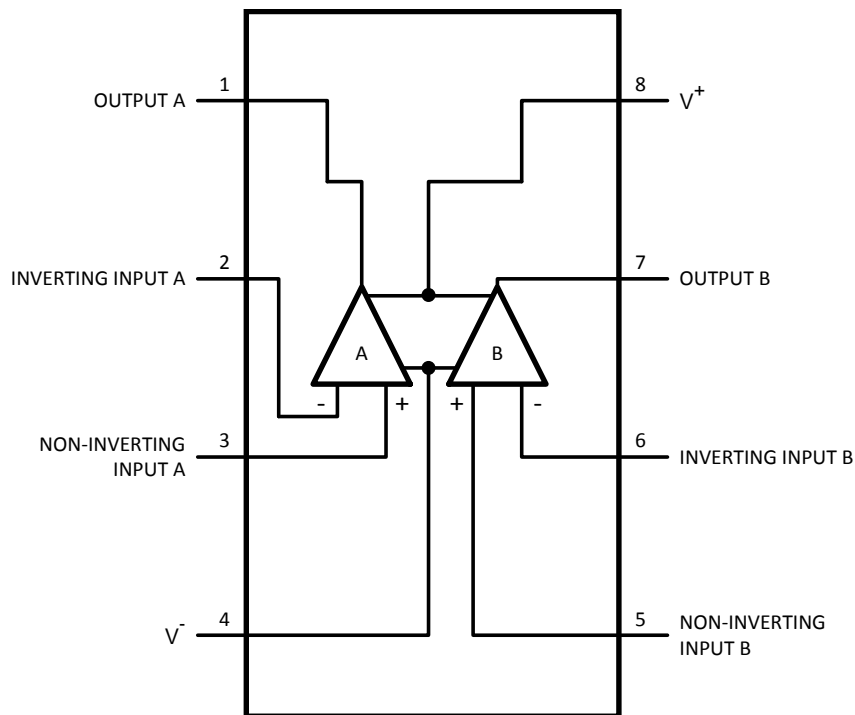

**Figure 2. 8-Lead SOIC
See D Package**



These devices have limited built-in ESD protection. The leads should be shorted together or the device placed in conductive foam during storage or handling to prevent electrostatic damage to the MOS gates.

Absolute Maximum Ratings ⁽¹⁾⁽²⁾⁽³⁾

Supply Voltage ($V_S = V_{CC} - V_{EE}$)		38V
Storage Temperature		-65°C to 150°C
Input Voltage		(V-) - 0.7V to (V+) + 0.7V
Output Short Circuit ⁽⁴⁾		Continuous
ESD Susceptibility ⁽⁵⁾		2000V
ESD Susceptibility ⁽⁶⁾		200V
Junction Temperature (T_{JMAX})		150°C
Thermal Resistance	θ_{JA}	154°C/W
	θ_{JC}	27°C/W

- (1) "Absolute Maximum Ratings" indicate limits beyond which damage to the device may occur, including inoperability and degradation of device reliability and/or performance. Functional operation of the device and/or non-degradation at the *Absolute Maximum Ratings* or other conditions beyond those indicated in the *Recommended Operating Conditions* is not implied. The *Recommended Operating Conditions* indicate conditions at which the device is functional and the device should not be operated beyond such conditions. All voltages are measured with respect to the ground pin, unless otherwise specified.
- (2) The *Electrical Characteristics* tables list specifications under the listed *Recommended Operating Conditions* except as otherwise modified or specified by the *Electrical Characteristics Conditions* and/or Notes. Typical specifications are estimations only and are not ensured.
- (3) If Military/Aerospace specified devices are required, please contact the Texas Instruments Sales Office/ Distributors for availability and specifications.
- (4) The maximum power dissipation must be derated at elevated temperatures and is dictated by T_{JMAX} , θ_{JA} , and the ambient temperature, T_A . The maximum allowable power dissipation is $P_{DMAX} = (T_{JMAX} - T_A) / \theta_{JA}$ or the number given in *Absolute Maximum Ratings*, whichever is lower. For the LME49722, $T_{JMAX} = 150^\circ\text{C}$ and the typical θ_{JC} is 27°C/W.
- (5) Human body model, applicable std. JESD22-A114C.
- (6) Machine model, applicable std. JESD22-A115-A.

Operating Ratings

Temperature Range	$T_{MIN} \leq T_A \leq T_{MAX}$	$-40^\circ\text{C} \leq T_A \leq 85^\circ\text{C}$
Supply Voltage Range		$\pm 2.5\text{V} \leq V_S \leq \pm 18\text{V}$

Electrical Characteristics for the LME49722 (1)(2)

The following specifications apply for $V_S = \pm 15V$ and $\pm 18V$, $R_L = 2k\Omega$, $f_{IN} = 1kHz$ unless otherwise specified. Limits apply for $T_A = 25^\circ C$,

Symbol	Parameter	Conditions	LME49722		Units (Limits)
			Typical (3)	Limit (4)	
THD+N	Total Harmonic Distortion + Noise	$A_V = 1$, $V_{OUT} = 3V_{rms}$ $R_L = 2k\Omega$ $R_L = 600\Omega$	0.00002 0.00002	0.00009	% % (max)
IMD	Intermodulation Distortion	$A_V = 1$, $V_{OUT} = 3V_{RMS}$ Two-tone, 60Hz & 7kHz 4:1	0.00002		%
GBWP	Gain Bandwidth Product	$f_{IN} = 100kHz$	55	45	MHz (min)
SR	Slew Rate	$A_V = 1$, $V_{OUT} = 10V_{P-P}$	± 22	± 15	V/ μs (min)
FPBW	Full Power Bandwidth	$V_{OUT} = 1V_{P-P}$, $-3dB$ referenced to output magnitude at $f = 1kHz$	12		MHz
t_s	Settling time	$A_V = -1$, 10V step, $C_L = 100pF$ 0.1% error range	1.2		μs
e_{INV}	Equivalent Input Voltage Noise	$f_{BW} = 20Hz$ to 20kHz	0.25	0.35	μV_{RMS} (max)
e_N	Equivalent Input Voltage Density	$f = 1kHz$ $V_S = \pm 15V$ $V_S = \pm 18V$	1.9 1.9	2.5	$nV\sqrt{Hz}$ $nV\sqrt{Hz}$ (max)
		$f = 10Hz$ $V_S = \pm 15V$ $V_S = \pm 18V$	2.8 3.2		$nV\sqrt{Hz}$ $nV\sqrt{Hz}$
I_n	Current Noise Density	$f = 1kHz$ $f = 10Hz$	2.6 6		$pA\sqrt{Hz}$ $pA\sqrt{Hz}$
V_{OS}	Offset Voltage	$V_{CM} = 0V$	± 0.02	± 0.7	mV (max)
PSRR	Power Supply Rejection Ratio	$\Delta V_S = 20V^{(5)}$	120	110	dB (min)
ISO _{CH-CH}	Channel-to-Channel Isolation	$f_{IN} = 1kHz$	136		dB
		$f_{IN} = 20kHz$	135		dB
I_B	Input Bias Current	$V_{CM} = 0V$ $V_S = \pm 15V$ $V_S = \pm 18V$	50 53	200	nA nA (max)
		$-40^\circ C \leq T_A \leq 85^\circ C$	0.1		nA/ $^\circ C$
I_{OS}	Input Offset Current	$V_{CM} = 0V$ $V_S = \pm 15V$ $V_S = \pm 18V$	25 32	100	nA nA (max)
V_{IN-CM}	Common-Mode Input Voltage Range	$V_S = \pm 15V$	+14.0 -13.9	$(V_{CC}) - 2.0$ $(V_{EE}) + 2.0$	V (min) V (min)
		$V_S = \pm 18V$	+17.0 -16.9	$(V_{CC}) - 2.0$ $(V_{EE}) + 2.0$	V (min) V (min)
CMRR	Common-Mode Rejection	$-10V \leq V_{CM} \leq 10V$	128	110	dB (min)
Z_{IN}	Differential Input Impedance		30		k Ω
Z_{CM}	Common Mode Input Impedance	$-10V \leq V_{CM} \leq 10V$	1000		M Ω
A_{VOL}	Open Loop Voltage Gain	$-12V \leq V_{OUT} \leq 12V$, $R_L = 600\Omega$	135	120	dB
		$-12V \leq V_{OUT} \leq 12V$, $R_L = 2k\Omega$	140		dB
		$-12V \leq V_{OUT} \leq 12V$, $R_L = 10k\Omega$	140		dB

- (1) "Absolute Maximum Ratings" indicate limits beyond which damage to the device may occur, including inoperability and degradation of device reliability and/or performance. Functional operation of the device and/or non-degradation at the Absolute Maximum Ratings or other conditions beyond those indicated in the Recommended Operating Conditions is not implied. The Recommended Operating Conditions indicate conditions at which the device is functional and the device should not be operated beyond such conditions. All voltages are measured with respect to the ground pin, unless otherwise specified.
- (2) The Electrical Characteristics tables list specifications under the listed Recommended Operating Conditions except as otherwise modified or specified by the Electrical Characteristics Conditions and/or Notes. Typical specifications are estimations only and are not ensured.
- (3) Typical values represent most likely parametric norms at $T_A = +25^\circ C$, and at the Recommended Operation Conditions at the time of product characterization and are not ensured.
- (4) Datasheet min/max specification limits are specified by test or statistical analysis.
- (5) PSRR is measured as follow: V_{OS} is measured at two supply voltages, $\pm 5V$ and $\pm 15V$. $PSRR = |20\log(\Delta V_{OS}/\Delta V_S)|$.

Electrical Characteristics for the LME49722 ⁽¹⁾⁽²⁾ (continued)

The following specifications apply for $V_S = \pm 15V$ and $\pm 18V$, $R_L = 2k\Omega$, $f_{IN} = 1kHz$ unless otherwise specified. Limits apply for $T_A = 25^\circ C$,

Symbol	Parameter	Conditions	LME49722		Units (Limits)
			Typical ⁽³⁾	Limit ⁽⁴⁾	
V_{OM}	Output Voltage Swing	$V_S = \pm 15V$ $R_L = 600\Omega$ $R_L = 2k\Omega$ $R_L = 10k\Omega$	+13.7/–14 ± 14.0 ± 14.1		V_{PEAK} V_{PEAK} V_{PEAK}
		$V_S = \pm 18V$ $R_L = 600\Omega$ $R_L = 2k\Omega$ $R_L = 10k\Omega$	+16.6/–16.8 ± 17.0 ± 17.1	± 15.5	$V_{PEAK} (min)$ V_{PEAK} V_{PEAK}
I_{OUT}	Output Current	$R_L = 600\Omega$ $V_S = \pm 15V$ $V_S = \pm 18V$	± 23 $\pm 27.6/–28$	± 23	mA mA (min)
I_{OUT-CC}	Short Circuit Current	Sink to Source	+43 –40		mA mA
Z_{OUT}	Output Impedance	$f_{IN} = 10kHz$ Closed-Loop Open-Loop	0.01 13		Ω Ω
I_S	Total Quiescent Power Supply Current	$I_{OUT} = 0mA$ $V_S = \pm 15V$ $V_S = \pm 18V$	12.1 12.3	16	mA mA (max)

Typical Performance Characteristics

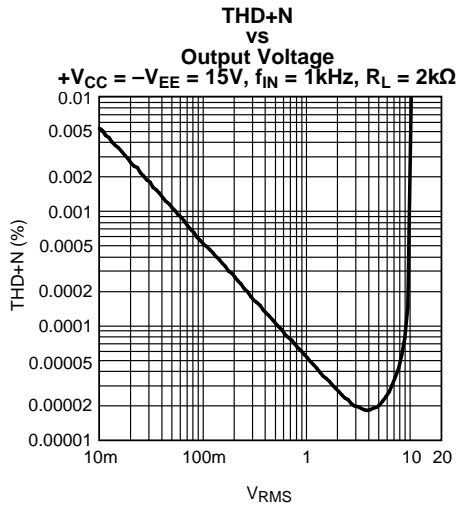

Figure 3.

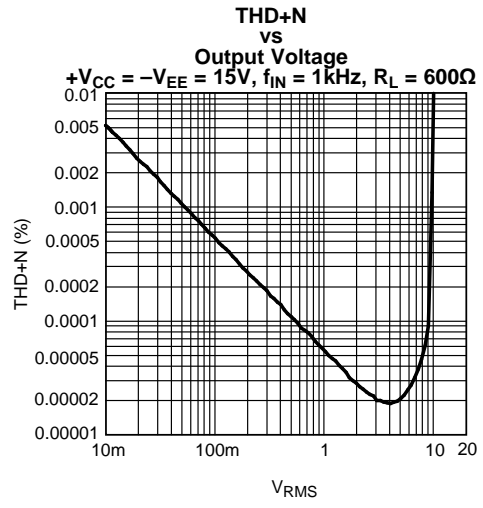

Figure 4.

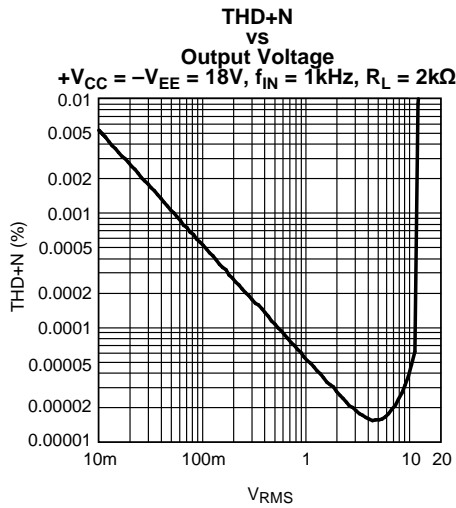

Figure 5.

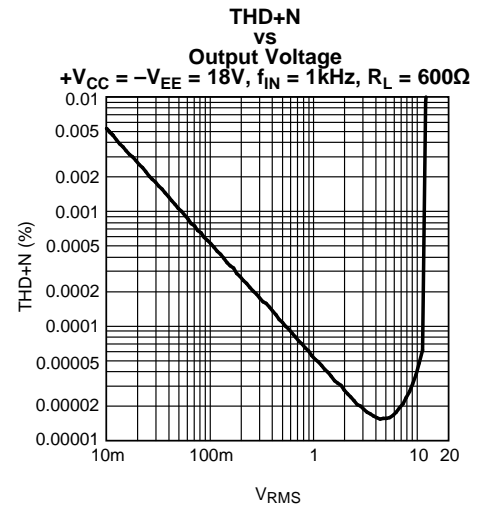

Figure 6.

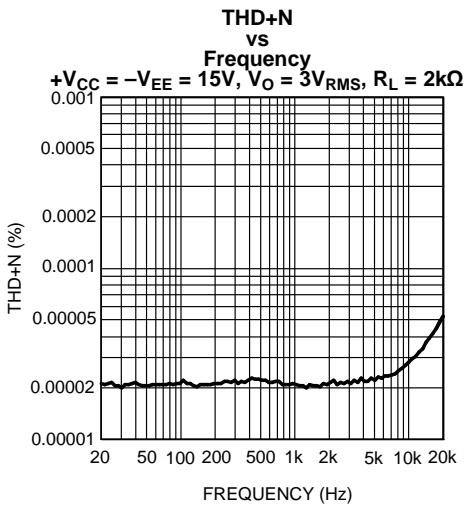

Figure 7.

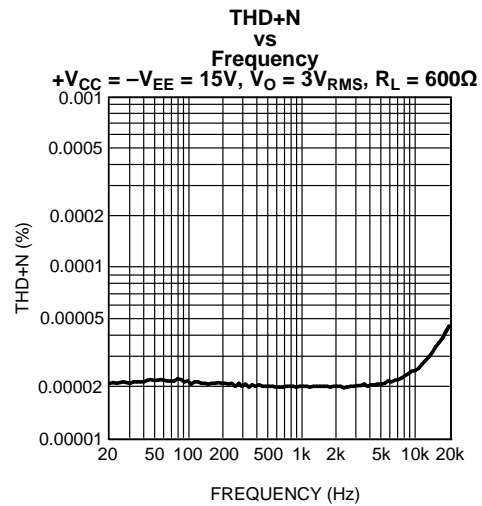

Figure 8.

Typical Performance Characteristics (continued)

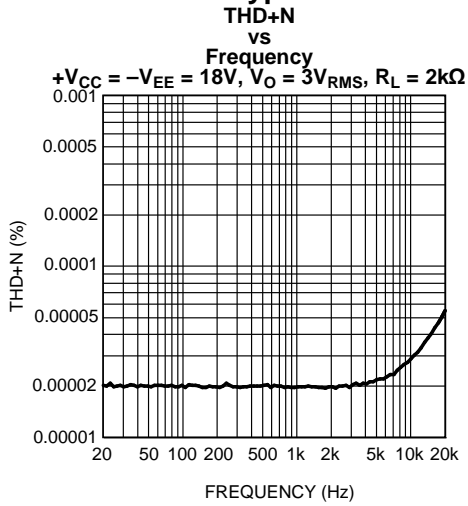

Figure 9.

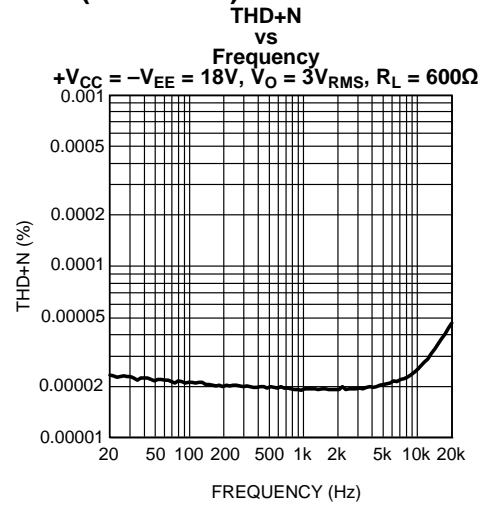

Figure 10.

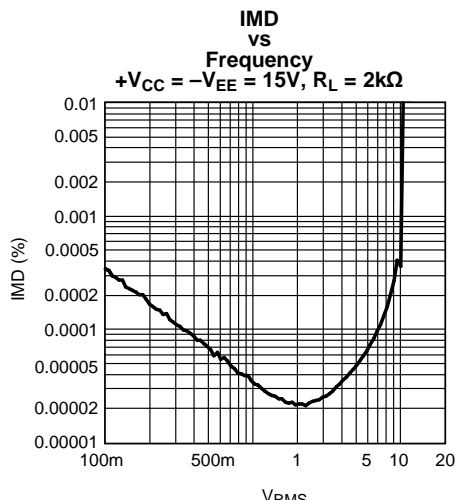

Figure 11.

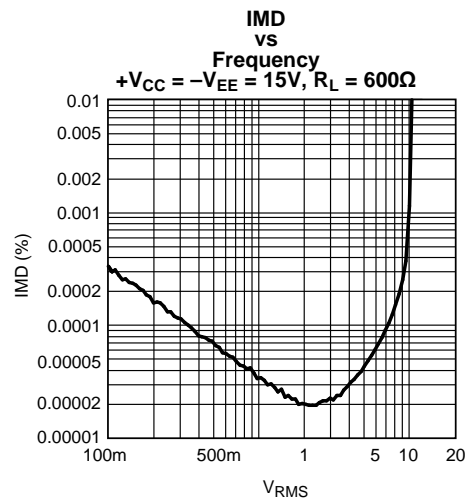

Figure 12.

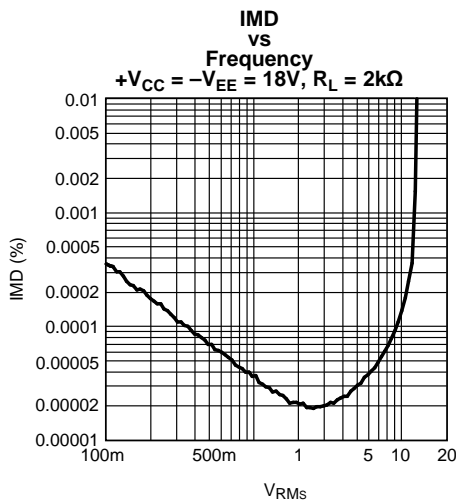

Figure 13.

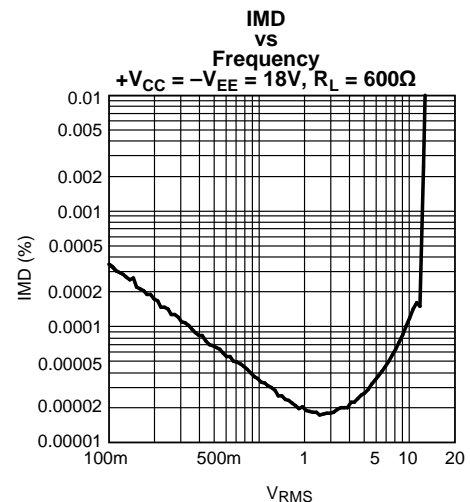

Figure 14.

Typical Performance Characteristics (continued)

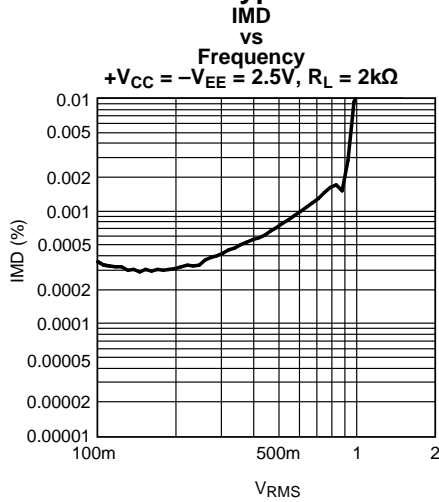

Figure 15.

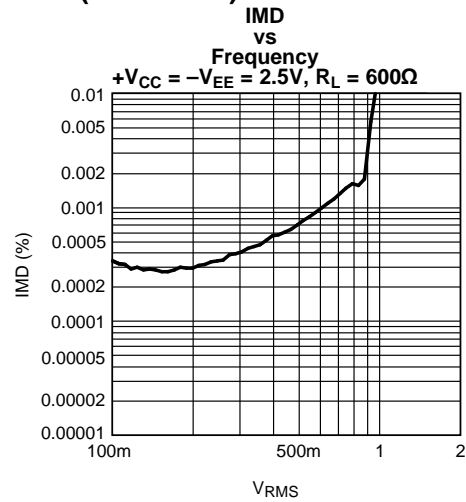

Figure 16.

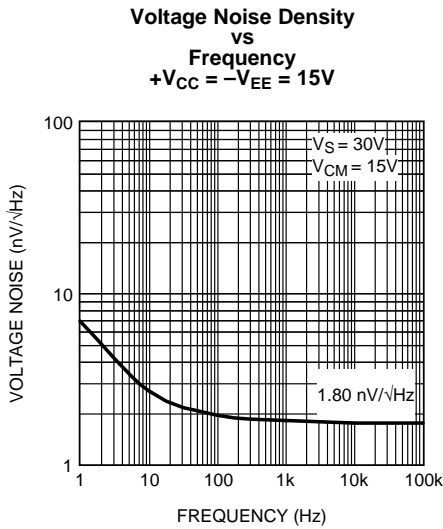

Figure 17.

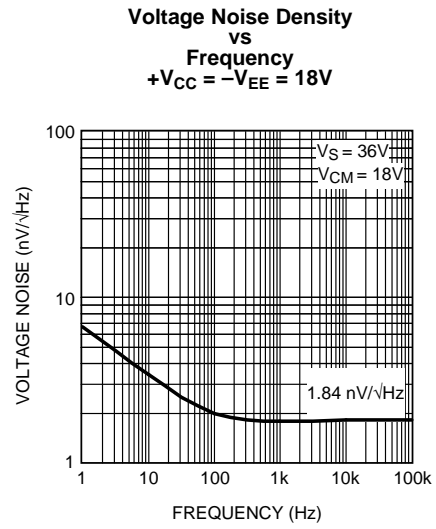

Figure 18.

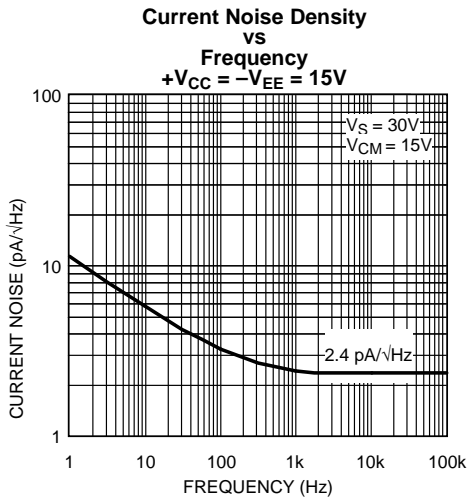

Figure 19.

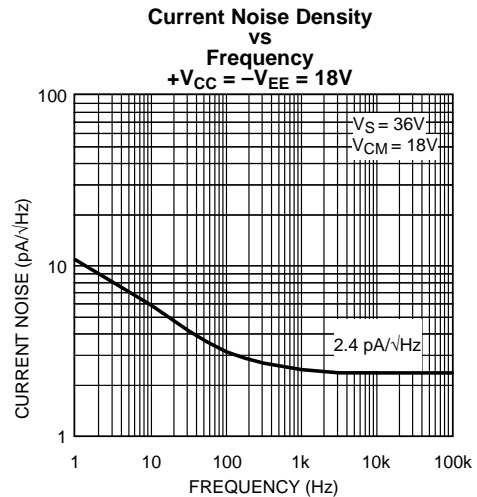

Figure 20.

Typical Performance Characteristics (continued)

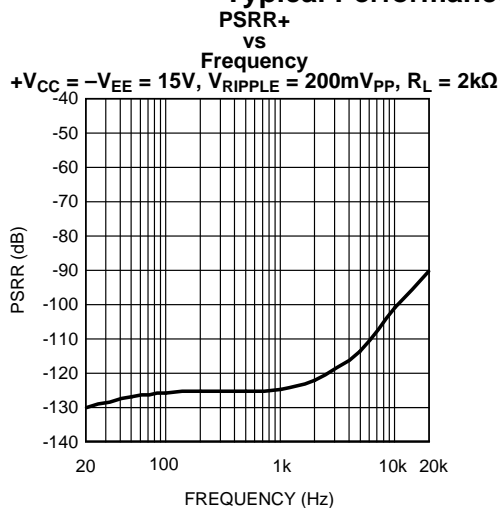

Figure 21.

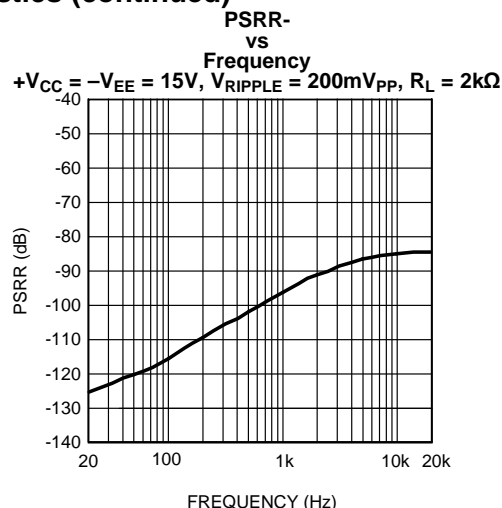

Figure 22.

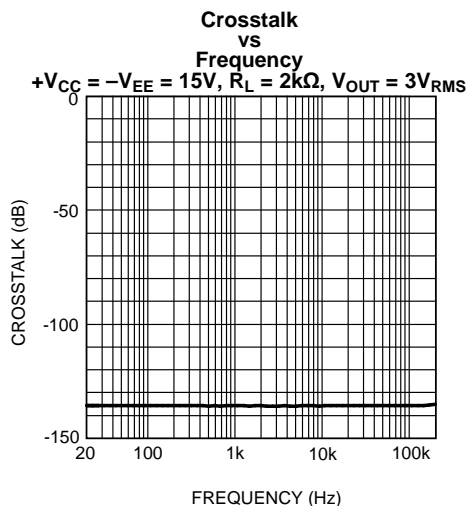

Figure 23.

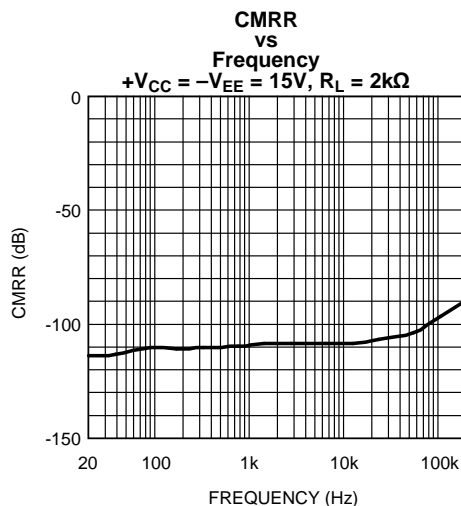

Figure 24.

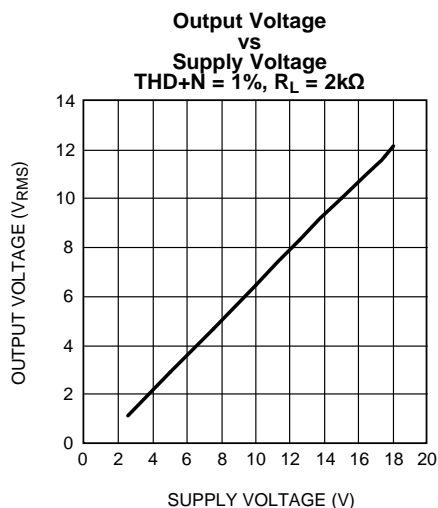

Figure 25.

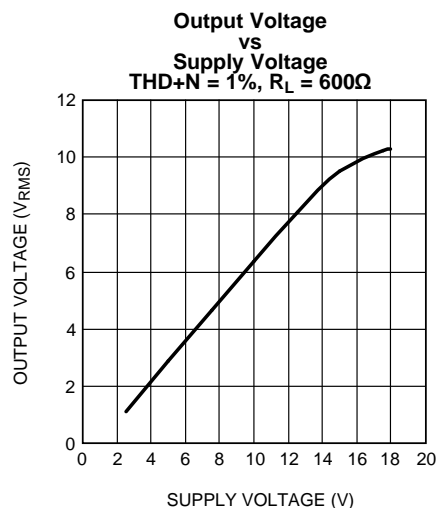

Figure 26.

Typical Performance Characteristics (continued)

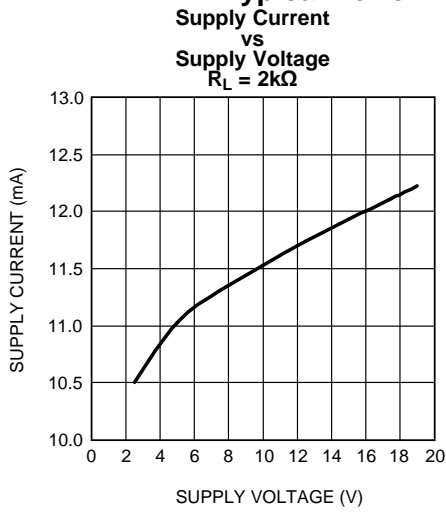

Figure 27.

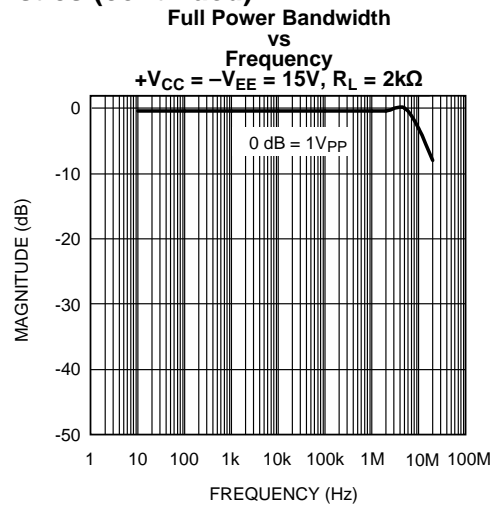

Figure 28.

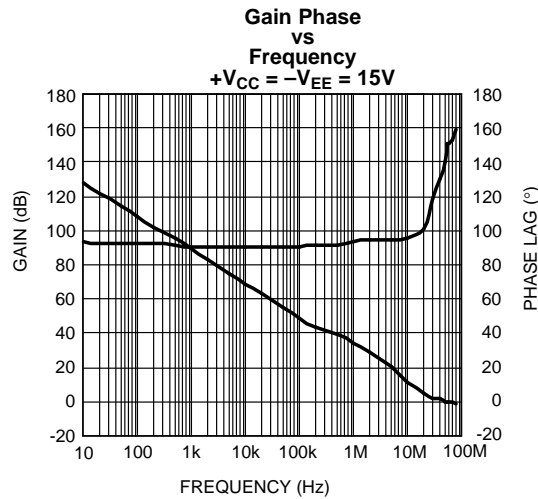
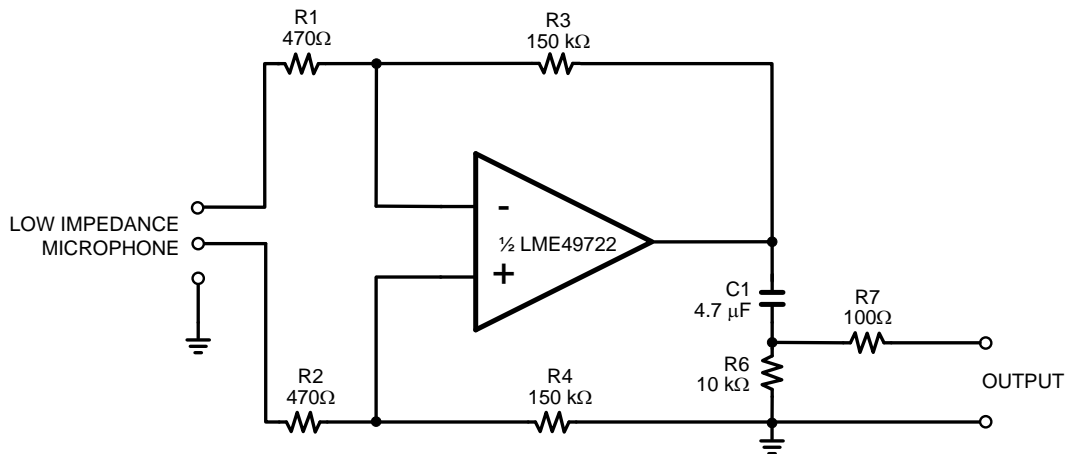

Figure 29.

APPLICATION INFORMATION

APPLICATION HINTS

The LME49722 is a high speed operational amplifier which can operate stably in most of the applications. For the application with gain greater than 2, capacitive loads up to 100pF will cause little change in the phase characteristics of the amplifiers and are therefore allowable. Capacitive loads greater than 10pF must be isolated from the output, if the gain value is less than 2. The most straightforward way to do this is to put a resistor (its value $\geq 20\Omega$) in series with the output. The resistor will also prevent unnecessary power dissipation if the output is accidentally shorted.



- Total voltage noise density: $e_{N_total}^2 \approx e_N^2 + e_{N_R1}^2 + e_{N_R2}^2 = 1.9^2 + 2(2.7^2)$,
then $e_{N_total} = 4.3$ nV/ $\sqrt{\text{Hz}}$. For $e_{N_R1} = e_{N_R2} \approx 2.7$ nV/ $\sqrt{\text{Hz}}$, if $R1 = R2 \approx 470\Omega$.
- Or total voltage noise = 0.13 μV input referred in a 1 kHz noise bandwidth.

Figure 30. Low Impedance Microphone Pre-amplifier

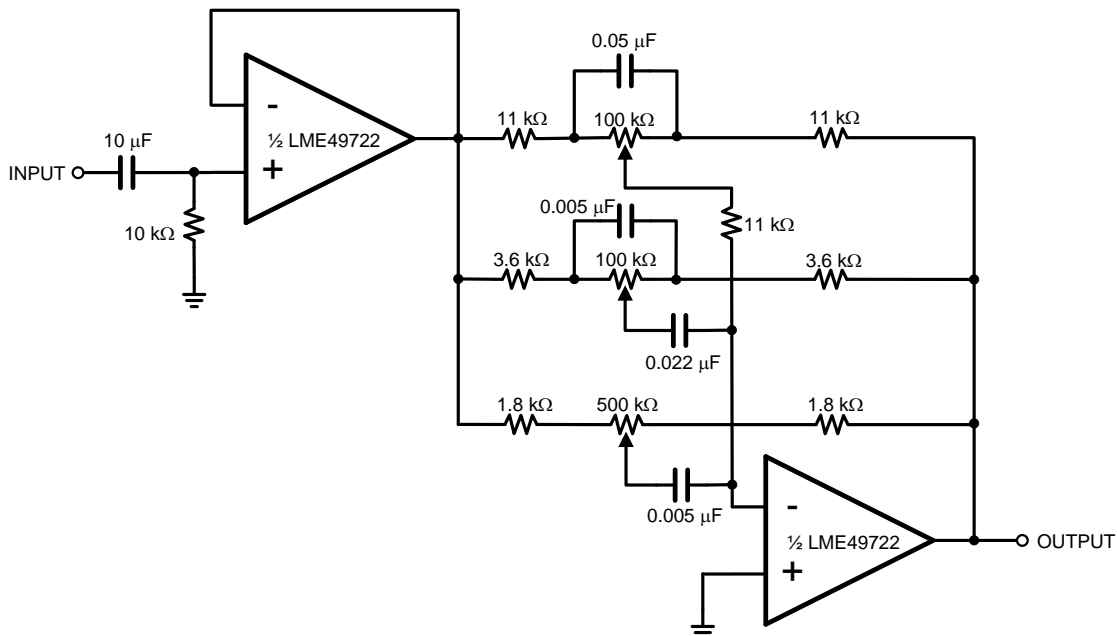

Figure 31. Three-Band Active Tone Control

REVISION HISTORY

Rev	Date	Description
1.0	03/27/08	Initial release.
A	04/04/13	Changed layout of National Data Sheet to TI format.

IMPORTANT NOTICE

Texas Instruments Incorporated and its subsidiaries (TI) reserve the right to make corrections, enhancements, improvements and other changes to its semiconductor products and services per JESD46, latest issue, and to discontinue any product or service per JESD48, latest issue. Buyers should obtain the latest relevant information before placing orders and should verify that such information is current and complete. All semiconductor products (also referred to herein as "components") are sold subject to TI's terms and conditions of sale supplied at the time of order acknowledgment.

TI warrants performance of its components to the specifications applicable at the time of sale, in accordance with the warranty in TI's terms and conditions of sale of semiconductor products. Testing and other quality control techniques are used to the extent TI deems necessary to support this warranty. Except where mandated by applicable law, testing of all parameters of each component is not necessarily performed.

TI assumes no liability for applications assistance or the design of Buyers' products. Buyers are responsible for their products and applications using TI components. To minimize the risks associated with Buyers' products and applications, Buyers should provide adequate design and operating safeguards.

TI does not warrant or represent that any license, either express or implied, is granted under any patent right, copyright, mask work right, or other intellectual property right relating to any combination, machine, or process in which TI components or services are used. Information published by TI regarding third-party products or services does not constitute a license to use such products or services or a warranty or endorsement thereof. Use of such information may require a license from a third party under the patents or other intellectual property of the third party, or a license from TI under the patents or other intellectual property of TI.

Reproduction of significant portions of TI information in TI data books or data sheets is permissible only if reproduction is without alteration and is accompanied by all associated warranties, conditions, limitations, and notices. TI is not responsible or liable for such altered documentation. Information of third parties may be subject to additional restrictions.

Resale of TI components or services with statements different from or beyond the parameters stated by TI for that component or service voids all express and any implied warranties for the associated TI component or service and is an unfair and deceptive business practice. TI is not responsible or liable for any such statements.

Buyer acknowledges and agrees that it is solely responsible for compliance with all legal, regulatory and safety-related requirements concerning its products, and any use of TI components in its applications, notwithstanding any applications-related information or support that may be provided by TI. Buyer represents and agrees that it has all the necessary expertise to create and implement safeguards which anticipate dangerous consequences of failures, monitor failures and their consequences, lessen the likelihood of failures that might cause harm and take appropriate remedial actions. Buyer will fully indemnify TI and its representatives against any damages arising out of the use of any TI components in safety-critical applications.

In some cases, TI components may be promoted specifically to facilitate safety-related applications. With such components, TI's goal is to help enable customers to design and create their own end-product solutions that meet applicable functional safety standards and requirements. Nonetheless, such components are subject to these terms.

No TI components are authorized for use in FDA Class III (or similar life-critical medical equipment) unless authorized officers of the parties have executed a special agreement specifically governing such use.

Only those TI components which TI has specifically designated as military grade or "enhanced plastic" are designed and intended for use in military/aerospace applications or environments. Buyer acknowledges and agrees that any military or aerospace use of TI components which have **not** been so designated is solely at the Buyer's risk, and that Buyer is solely responsible for compliance with all legal and regulatory requirements in connection with such use.

TI has specifically designated certain components as meeting ISO/TS16949 requirements, mainly for automotive use. In any case of use of non-designated products, TI will not be responsible for any failure to meet ISO/TS16949.

Products

Audio	www.ti.com/audio
Amplifiers	amplifier.ti.com
Data Converters	dataconverter.ti.com
DLP® Products	www.dlp.com
DSP	dsp.ti.com
Clocks and Timers	www.ti.com/clocks
Interface	interface.ti.com
Logic	logic.ti.com
Power Mgmt	power.ti.com
Microcontrollers	microcontroller.ti.com
RFID	www.ti-rfid.com
OMAP Applications Processors	www.ti.com/omap
Wireless Connectivity	www.ti.com/wirelessconnectivity

Applications

Automotive and Transportation	www.ti.com/automotive
Communications and Telecom	www.ti.com/communications
Computers and Peripherals	www.ti.com/computers
Consumer Electronics	www.ti.com/consumer-apps
Energy and Lighting	www.ti.com/energy
Industrial	www.ti.com/industrial
Medical	www.ti.com/medical
Security	www.ti.com/security
Space, Avionics and Defense	www.ti.com/space-avionics-defense
Video and Imaging	www.ti.com/video

TI E2E Community

e2e.ti.com

Mouser Electronics

Authorized Distributor

Click to View Pricing, Inventory, Delivery & Lifecycle Information:

[Texas Instruments:](#)

[LME49722MA/NOPB](#) [LME49722MAX/NOPB](#)