

> **Features**

- High Current
- Low On-Resistance
- No Secondary Breakdown
- Low Driving Power
- High Forward Transconductance
- Avalanche Proof
- Including G-S Zener-Diode

> **Applications**

- Motor Control
- General Purpose Power Amplifier
- DC-DC Converters

> **Outline Drawing**

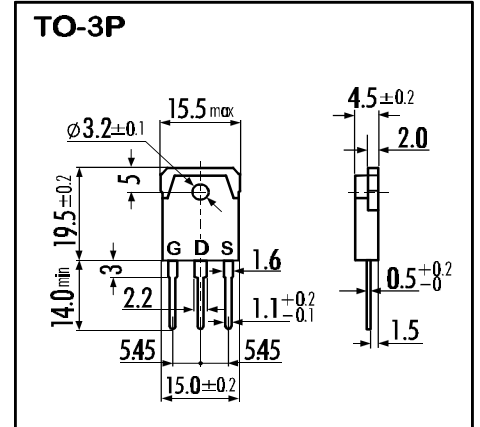

> **Maximum Ratings and Characteristics**

- Absolute Maximum Ratings (T<sub>C</sub>=25°C), unless otherwise specified

Item	Symbol	Rating	Unit
Drain-Source-Voltage	V <sub>DS</sub>	60	V
Drain-Gate-Voltage (R <sub>GS</sub> =20KΩ)	V <sub>DGR</sub>	60	V
Continous Drain Current	I <sub>D</sub>	50	A
Pulsed Drain Current	I <sub>D(puls)</sub>	200	A
Gate-Source-Voltage	V <sub>GS</sub>	±20	V
Max. Power Dissipation	P <sub>D</sub>	125	W
Operating and Storage Temperature Range	T <sub>ch</sub>	150	°C
	T <sub>stg</sub>	-55 ~ +150	°C

> **Equivalent Circuit**

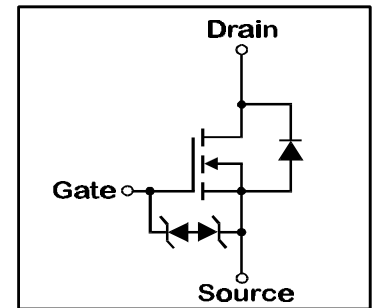

- Electrical Characteristics (T<sub>C</sub>=25°C), unless otherwise specified

Item	Symbol	Test conditions	Min.	Typ.	Max.	Unit
Drain-Source Breakdown-Voltage	V <sub>(BR)DSS</sub>	I <sub>D</sub> =1mA V <sub>GS</sub> =0V	60			V
Gate Threshold Voltage	V <sub>GS(th)</sub>	I <sub>D</sub> =1mA V <sub>DS</sub> =V <sub>GS</sub>	1,0	1,5	2,0	V
Zero Gate Voltage Drain Current	I <sub>DSS</sub>	V <sub>DS</sub> =60V T <sub>ch</sub> =25°C			500	μA
		V <sub>GS</sub> =0V T <sub>ch</sub> =125°C			1,0	mA
Gate Source Leakage Current	I <sub>GSS</sub>	V <sub>GS</sub> =±16V V <sub>DS</sub> =0V			10,0	μA
Drain Source On-State Resistance	R <sub>DS(on)</sub>	I <sub>D</sub> =25A V <sub>GS</sub> =4V		0,019	0,027	Ω
		I <sub>D</sub> =25A V <sub>GS</sub> =10V		0,013	0,017	Ω
Forward Transconductance	g <sub>fs</sub>	I <sub>D</sub> =25A V <sub>DS</sub> =25V	20	40		S
Input Capacitance	C <sub>iss</sub>	V <sub>DS</sub> =25V		2600	3900	pF
Output Capacitance	C <sub>oss</sub>	V <sub>GS</sub> =0V		1000	1500	pF
Reverse Transfer Capacitance	C <sub>rss</sub>	f=1MHz		630	950	pF
Turn-On-Time t <sub>on</sub> (t <sub>on</sub> =t <sub>d(on)</sub> +t <sub>r</sub> )	t <sub>d(on)</sub>	V <sub>CC</sub> =30V I <sub>D</sub> =50A		20	30	ns
			t <sub>r</sub>		210	320
Turn-Off-Time t <sub>off</sub> (t <sub>off</sub> =t <sub>d(off)</sub> +t <sub>f</sub> )	t <sub>d(off)</sub>	V <sub>GS</sub> =10V R <sub>GS</sub> =25Ω		520	780	ns
			t <sub>f</sub>		420	630
Avalanche Capability	I <sub>AV</sub>	L = 100μH T <sub>ch</sub> =25°C	50			A
Continous Reverse Drain Current	I <sub>DR</sub>				50	A
Pulsed Reverse Drain Current	I <sub>DRM</sub>				200	A
Diode Forward On-Voltage	V <sub>SD</sub>	I <sub>F</sub> =2xI <sub>DR</sub> V <sub>GS</sub> =0V T <sub>ch</sub> =25°C		1,45	2,18	V
Reverse Recovery Time	t <sub>rr</sub>	I <sub>F</sub> =I <sub>DR</sub> V <sub>GS</sub> =0V		85	120	ns
Reverse Recovery Charge	Q <sub>rr</sub>	-di <sub>F</sub> /dt=100A/μs T <sub>ch</sub> =25°C		0,16		μC

- Thermal Characteristics

Item	Symbol	Test conditions	Min.	Typ.	Max.	Unit
Thermal Resistance	R <sub>th(ch-a)</sub>	channel to air			35	°C/W
	R <sub>th(ch-c)</sub>	channel to case			1,0	°C/W

N-channel MOS-FET			
60V	0,017Ω	50A	125W

# 2SK1969-01

## FAP-III A Series



### > Characteristics

Typical Output Characteristics

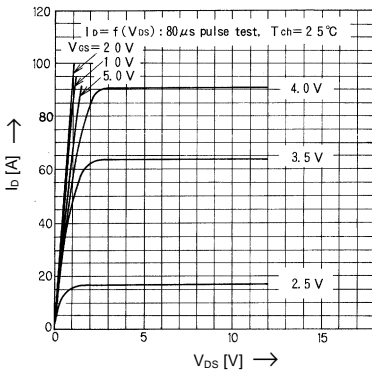

Drain-Source-On-State Resistance vs. T<sub>ch</sub>

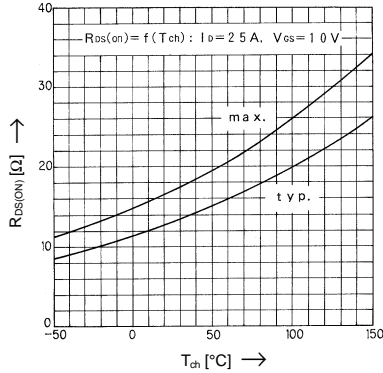

Typical Transfer Characteristics

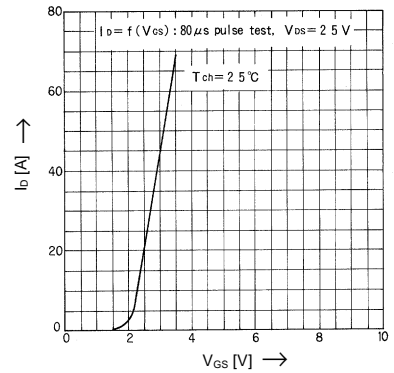

Typical Drain-Source-On-State-Resistance vs. Id

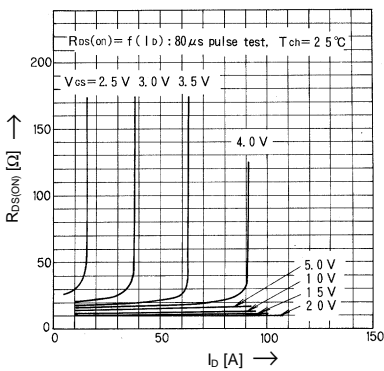

Typical Forward Transconductance vs. Id

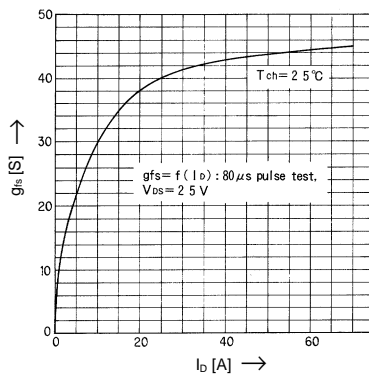

Gate Threshold Voltage vs. T<sub>ch</sub>

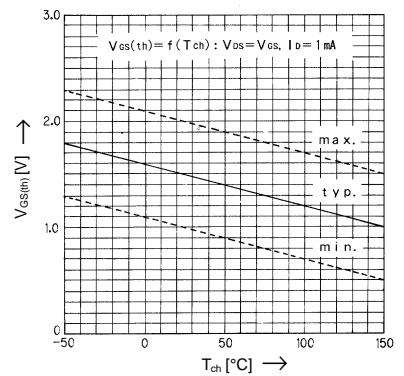

Typical Capacitance vs. V<sub>DS</sub>

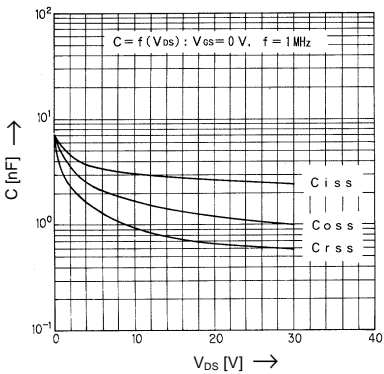

Typical Input Charge

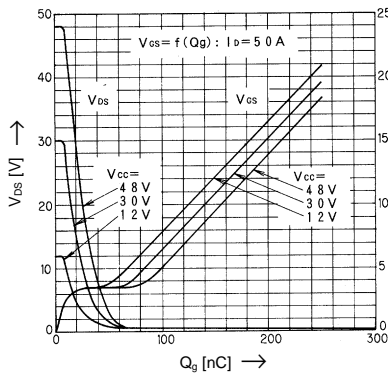

Forward Characteristics of Reverse Diode

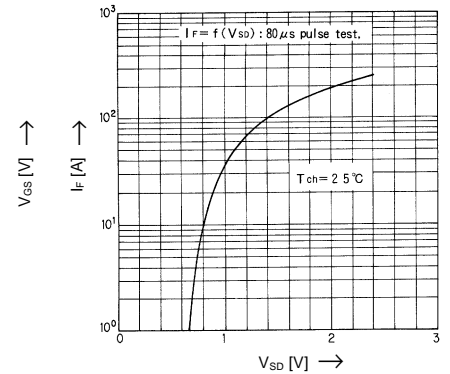

Allowable Power Dissipation vs. T<sub>C</sub>

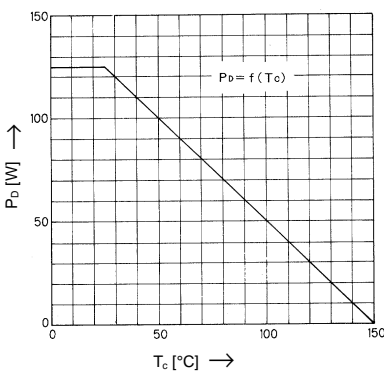

Safe operation area

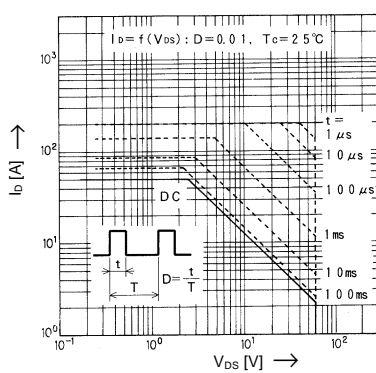

↑

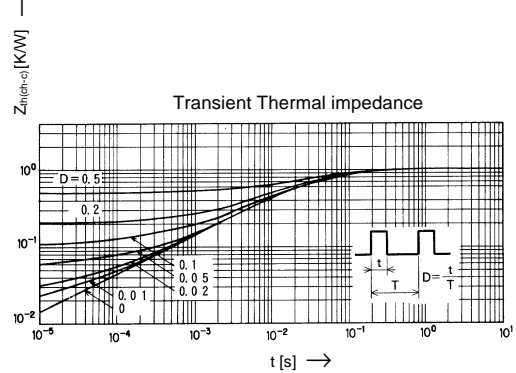

This datasheet has been download from:

[www.datasheetcatalog.com](http://www.datasheetcatalog.com)

Datasheets for electronics components.